

SM2-I

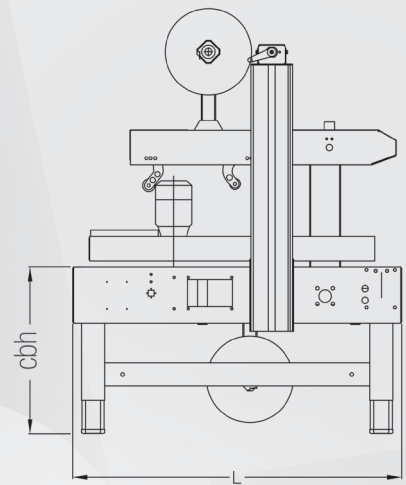

other languages: www.siat.com

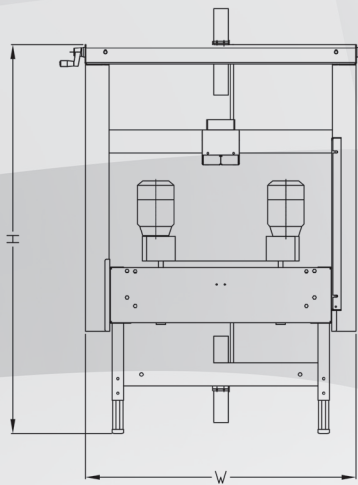

- > Machine dimensions
- Dimensioni macchina
- Machinemessungen
- Dimensions machine
- Dimensiones de máquina

Size / Weight packaging			LxWxH
> SM2-I	185	220	120x106x116

> SM2-I

	Min.	Max
L	938	-
W	1140	-
H	1250	1590
cbh	480	820
AS 77	580	920
AS 80	680	1020

- > Taping units
- Unità nastranti
- Verschliesseinheiten
- Unité enrubanneuses
- Unidades de precinto

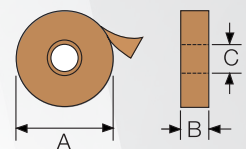

- > Box dimensions
- Dimensioni delle scatole
- Kartonabmessungen
- Dimensions des boîtes
- Dimensiones de cajas

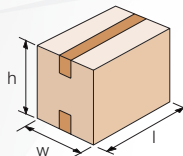

> SM2-I

	K11	
	Min.	Max
l	150	∞
w	140 / 170*	500
h	100	500

* With top side pressure rollers (min. width manageable 205mm)
Upper guides required in case of box width less than 205mm (optional)

	K11
	mm
A	410 Max
B	50
C	76

- > Production capacity
- Capacità di produzione
- Produktionskapazität
- Capacité de production
- Capacidad de producción

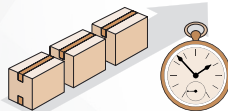

> SM2-I	Bph
Max pcs.*	1200

* Depending on operator dexterity

- > Standard voltage
- Voltaggio standard
- Standardspannung
- Tension standard
- Voltaje estándar

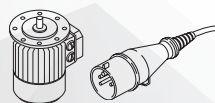

> SM2-I

380/415V - 50Hz	
Other voltages available on demand	
Amps	1,08
Power kW	0,26
Phase	3Ph + PE

- > Optionals
- Accessori
- Zubehör
- Accessories
- Accesorios

- > AS80
- Higher legs
- Set gambe più alte
- Höhere Stützen
- Pieds plus hauts
- Patas más altas

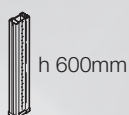

- > AS77
- Castors
- Set ruote
- Rädchen
- Roulettes
- Ruedas

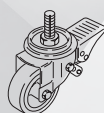

- > RG
- Roller conveyor
- Piani a rulli
- Rollenbahnen
- Plans à rouleaux
- Rodillos libres



- > GTL - GTR
- Extendable conveyor
- Rulliera estensibile
- Ausziehbare rollenbahnen
- Convoyeur extensible
- Rodillos extensibles

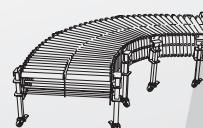

- > K-125 / K-250
- Inkjet printer
- Stampante ad inchiostro
- Tintenstrahldrucker
- Marqueur à jet d'encre
- Impresora de inyección de tinta

