

# F105 / PS50-TB

> F105

> PS50-TB

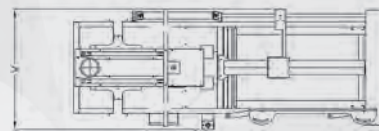
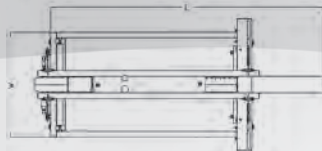
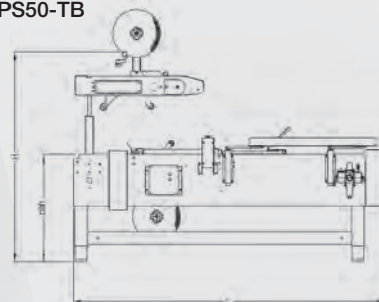
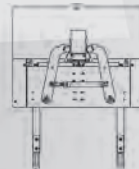
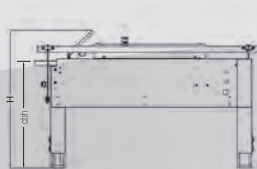

other languages: [www.siat.com](http://www.siat.com)



> **Machine dimensions**  
Dimensioni macchina  
Machinemessungen  
Dimensions machine  
Dimensiones de la màquina

Size / Weigth packaging			LxWxH 
> F105	110	125	148x88x95
> PS50	225	250	202x83x126

> F105

	Min.	Max
L	1260	1660
W	570	933
H	695	855
cbh	525	675
AS 77	775	935
AS 80	895	1055

> PS50-TB

	Min.	Max
L	1952	-
W	753	-
H	1305	1505
cbh	585	735
AS 77	685	885
AS 80	785	985

> **Taping units**  
Unità nastranti  
Verschliesseinheiten  
Unité enrubanneuse  
Unidades de precinto

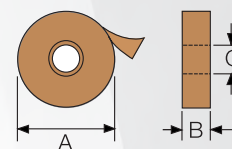

> **Box dimensions**  
Dimensioni delle scatole  
Kartonabmessungen  
Dimensions des boîtes  
Dimensiones de las cajas

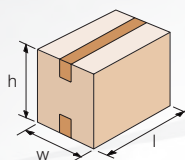

> F105

	Min.	Max
l	200	600
w	90	500
h	90	500

> PS50-TB

	K11R	
	Min.	Max
l	150	600
w	150	500
h	100	500

	K11R
	mm
A	410 Max
B	50
C	76

> **Production capacity**  
Capacità di produzione  
Produktionskapazität  
Capacité de production  
Capacidad de producción

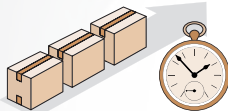

> F105

	Bph
Max pcs.*	600

> PS50-TB

	Bph
Max pcs.*	600

\* Always based on shorter manageable box

> **Air consumption**  
Consumo aria  
Druckluftverbrauch  
Consommation air comprimé  
Consumo de arie

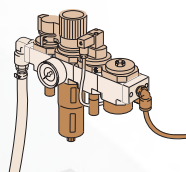

> F105 / PS50-TB

	NL.
Cycle	14,2

from 5,5 bar to 7 bar

> PS50-TB

<b>380/400V - 50Hz - 3F</b>	
<b>440V - 60Hz - 3F</b>	
Amps	1,08
Power kW	0,26
Phase	3Ph + N + PE

> **Standard voltage**  
Voltage standard  
Standardspannung  
Tension standard  
Voltage estándar

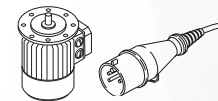

> **Optionals**  
Accessori  
Zübehör  
Accessories  
Accesorios

> **AS80**  
Higher legs  
Set gambe più alte  
Höhere Stützen  
Pieds plus hauts  
Patas más altas



> **AS77**  
Casters  
Set ruote  
Rädchen  
Roulettes  
Ruedas

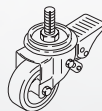

> **RG**  
Roller conveyor  
Piani a rulli  
Rollenbahnen  
Plans à rouleaux  
Rodillos libres



> **GTL - GTR**  
Extendable conveyor  
Rulliera estensibile  
Ausziehbare rollenbahnen  
Convoyeur extensible  
Rodillos extensibles

